

**QUADRIX**  
**DG 1000**  
**DG 1300**  
**DG 1600**  
**DG 2000**

CNC CUTTING  
WORK CENTRE



**DONATONI**  
HIGH INNOVATION STONE MACHINES

Highest quality For your skill

To highlight a machine and its potential often means to open the doors to new opportunities and markets



DONATONI



## INDEX

**05** ADVANTAGES

**07** MACHINING

**09** MAIN FEATURES

**11** MAIN COMPONENTS

**13** OPTIONS

**17** SOFTWARE

**25** SERVICES AND AFTER-SALES SERVICE

**27** TECHNICAL DATA

# STRENGTH AND FLEXIBILITY WITHOUT COMPROMISE

CNC WORK CENTRE



# GREAT FLEXIBILITY, GREAT PERFORMANCE

The **QUADRIX DG 1000 - 1300 - 1600 - 2000** are large dimension CNC multifunctional work centres with **5/6 interpolated axis** with Z stroke from 1000 up to 2000 mm. These models are greatly used for working profiles and shapes of all types, straight, concave, convex, arches, drilling in 2 and 3 dimensional works, columns, sculptures and all types of cutting process. The **Quadrix DG** are work centres designed to be very versatile with high production capacities. Thanks to its steel bridge and increased dimensions, to all the movements of each axis given by brushless motors and high precision gearboxes running on linear bearings and gears on both X and Y axis in oil bath, it is possible to produce precise various types of forms, sizes and objects.

The machines work with an electro-spindle controlled by inverter with an ISO 50 connection which can hold discs from 500 mm diam to 1200 mm and diamond tools such as router bits and drill bits to perform a wide range of processing.

The machines can be equipped with lathe and rotating platform controlled by CNC control, so bringing the axis controlled to 6. It is also possible to fit the machine as a bridge saw or as a complete CNC work centre thanks to the wide range of accessories available.

The **QUADRIX DG** are suited for the customer who wants to grow the company in order to open new doors and projects from an always demanding market of designers and architects.

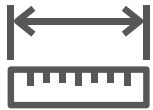

PRECISE



EXTREMELY STRONG



FLEXIBLE AND REALIABLE



SHAPING AND DRILLING SPECIFIC



ABLE TO CUT THICK PIECES



EASY TO USE



WIDE RANGE OF ACCESSORIES



# TECHNOLOGY AT THE SERVICE OF DESIGN AND ART



# PROCESSING

Columns, sculptures, bath tubs, wash basins, shower plates, panels for internal and external cladding, steps, window dressings, building material, monuments and head stones.



# THE SOLUTION FOR GREAT CHALLENGES

MAIN FEATURES





# TYPE OF PROCESSING



SHAPES



DRILLING



STATUES

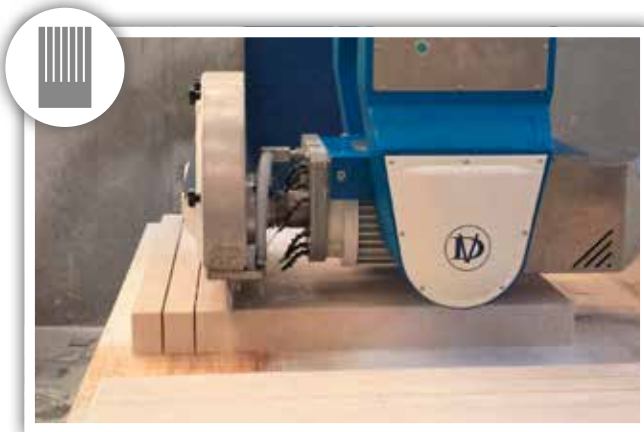

CUTTING



LATHE



MILLING

# MAIN FEATURES



## DG 1000

5/6 interpolated axis

Diameter min/max blade:  
500 - 1000 mm ( opt. 1100 mm)

Z axis stroke: 1000 mm

Max cutting depth: 360 mm (410 mm)

Tool connection ISO-50

X axis stroke: 3800 mm

Guides of X-Y axis in oil bath

Normalized, sandblasted and painted steel structure\*

Brushless motors and high precision gearbox controlled by inverter for X-Y-Z axis

Bi-rotary head – Tool head with continuous inclination from -20 to 200 degrees



## DG 1300

5/6 interpolated axis

Diameter min/max blade: 500 - 1000 mm  
(opt. 1200 mm)

Z axis stroke: 1300 mm

Max cutting depth: 360 mm  
(opt. 460 mm)

Tool connection ISO-50

X axis stroke: 4300 mm

Guides of X-Y axis in oil bath

Normalized, sandblasted and painted steel structure\*

Brushless motors and high precision gearbox controlled by inverter for X-Y-Z axis

Bi-rotary head – Tool head with continuous inclination from -20 to 200 degrees



## DG 1600

5/6 interpolated axis

Diameter min/max blade: 500-1000 mm  
(opt. 1200 mm)

Z axis stroke: 1600 mm

Max cutting depth: 360 mm  
(opt. 460 mm)

Tool connection ISO-50

X axis stroke: 4600 mm

Guides of X-Y axis in oil bath

Normalized, sandblasted and painted steel  
structure\*

Brushless motors and high precision gearbox controlled by inverter for X-Y-Z axis

Bi-rotary head – Tool head with continuous inclination from -20 to 200 degrees



## DG 2000

5/6 interpolated axis

Diameter min/max blade: 500-1000 mm  
(opt. 1200 mm)

Z axis stroke: 2000 mm

Max cutting depth: 360 mm  
(opt. 460 mm)

Tool connection ISO-50

X axis stroke: 4600 mm

Guides of X-Y axis in oil bath

Normalized, sandblasted and painted steel  
structure\*

Brushless motors and high precision gearbox controlled by inverter for X-Y-Z axis

Bi-rotary head – Tool head with continuous inclination from -20 to 200 degrees

\*Each model of the DG range has its own built structure. The bridge and rails are built according to the size of machine to grant rigidity and stability, in order to guarantee high working precision.

# INNOVATION IS STANDARD

MAIN COMPONENTS



**Electro-spindle** of very high quality, with twin rotating head installed on steel carriage controlled by inverter allowing to vary the speed of the blade or tool from 0 to 8000 rpm. Provided with Bi-rotary head – Tool with continuous inclination from -20 to 200 degrees, very useful with 5 axis work with blade or router tool. It is possible to use blades, drilling and router bits. The tools can be changed either manually or automatically.

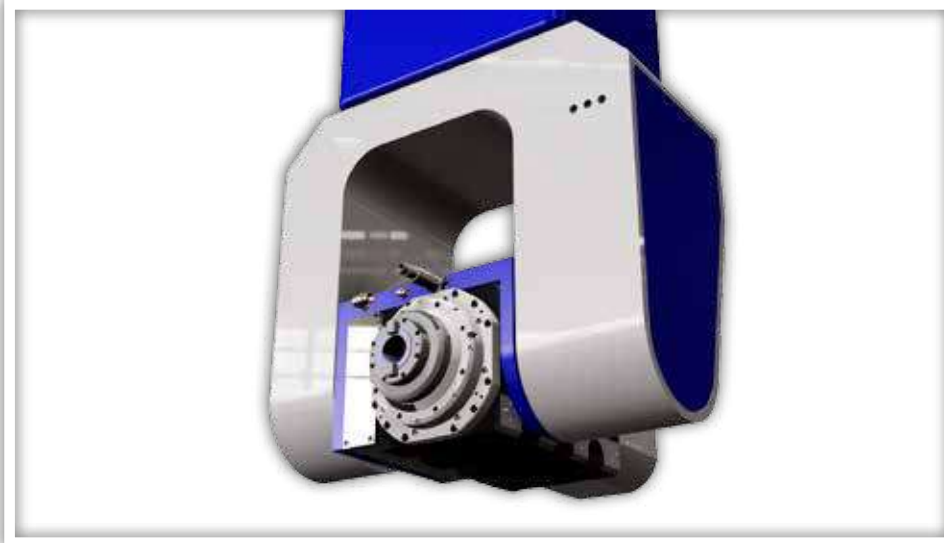

**Sliding cross-beams** with linear bearings and helicoidal-teeth racks for the X and Y axis, with oil bath lubrication and bellows for protection with labyrinth closure.

**Bridge:** designed to assure the best support to the sleeve and the electro-spindle and to guarantee maximum precision. The structure is in zinc-plated normalized steel, sandblasted and painted with 3 coats of paint.



# ACCESSORIES AND MECHANICAL COMPONENTS

OPTIONALS



**Working bench and platform:** available in different models, sizes and surfaces, with top in wood, steel, aluminum, with overbench, based on the selected accessories and on customer needs.

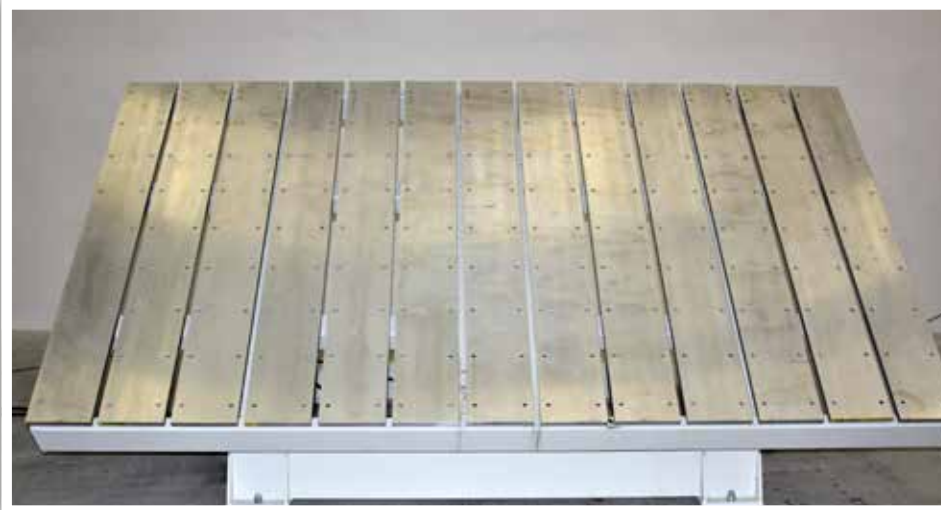

**Slab thickness detector:** automatic detection system of slab thickness.



**3d scanner ARTEC:** is a professional instrument to scan objects of various sizes such as statues, capitals for columns, objects of high design and any special shapes and forms of various dimensions in various formats.

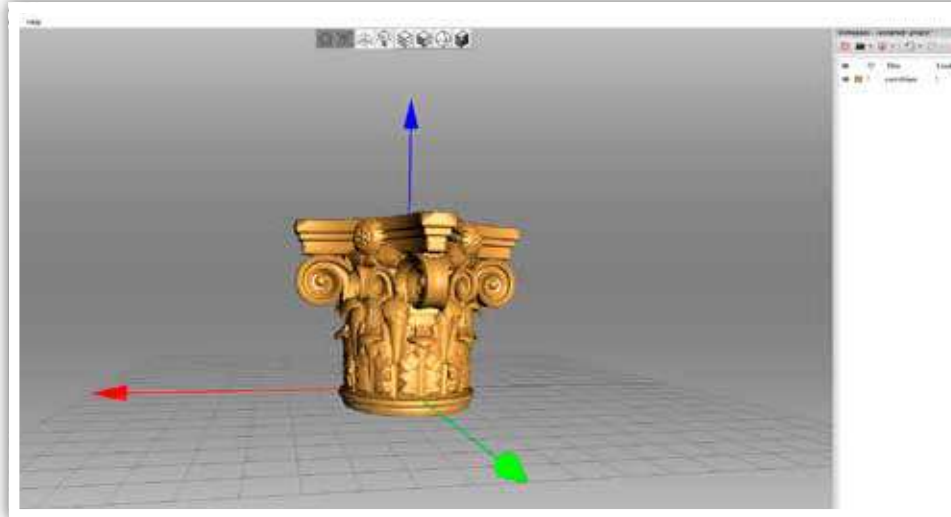

**Camera for slab:** Slab detection system, with camera placed above the workbench and image acquisition software. The application allows to speed up the machine programming, to position each piece and detect any slab defects.



**Linear tool storage** at 10 positions for ISO 50 cones with max. length 600 mm, complete with pneumatic- lifting stainless steel cover (only for ATC or MTB electrospindle).



**Rotary tool storage** at 16 positions for ISO 50 cones and two positions for vertical blade diam. 625 and 825 mm. The tool holder is placed alongside the machine and moves through a mobile base allowing to be placed within the working area to change the tool/blade. (Only for ATC or MTB electrospindle).



**Tool presetting:** tool thickness detector, essential for precise processing.





**Lathe:** interpolated lathe to produce columns of different sizes and complex forms



**Automatic blade change** to be combined with the ATC or MTB electrospindle (625 or 825 mm).



**Suction Cups Kit:** system for fixing the pieces by means of suction cups and vacuum pump (to be combined with fixed or tilting aluminum bench).

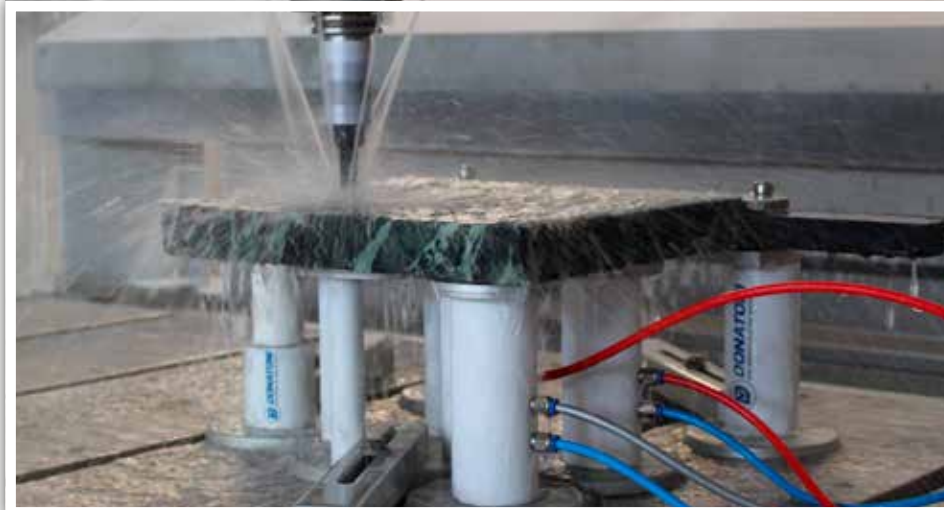

**Steel walls:** sandblasted and painted with 3 coats of paint.



# AN INTELLIGENT SYSTEM TO MAKE YOUR WORK EASIER

LET US DRIVE YOU TOWARDS  
AN INTELLIGENT CHOICE OF  
MACHINE



# D-INSIDE:

EQUIP YOURSELVES WITH  
A SUPERIOR FORM OF  
INTELLIGENCE



OPERATOR INTERFACE WITH PC AND 15" VIDEO

COLOUR TOUCH-SCREEN

PRECISION OF MOVEMENTS WHICH ENABLES  
COMPLEX AND INTRICATE PROCESSING

USB PORT FOR TRANSFERRING FILES

CONTROLS FOR MANUAL MOVEMENT OF AXES



Perfection in the machining is achieved through multiple movements that need perfect coordination between them. While in the human body all movements are managed through brain impulses, similarly in our machines the management of movements takes place through the **integration of the machine with the programming software.**

Every Donatoni machine is born with an intelligent work management system, integrated with all the parts that manages its movements; we call this system **D-Inside**, the real brain of the machine; it is an advanced but simple interface in terms of its usability, even for inexperienced operators, which enables the machine software system to be coordinated.

**The D-Inside system** offers many programming options and can be interfaced with the different kinds of Donatoni software, such as Parametrix and all additional modules, or the CAD-CAM DDX EasySTONE, in such a way as to make it possible to adapt the machine in the best way to suit the requirements of the customer.

# PARAMETRIX

USER-FRIENDLY ICONS AND  
SIMPLE PROGRAMMING

Parametrix is the simple and user-friendly Software developed by Donatoni Macchine and conceived to optimize the management of cutting different shaped pieces from slabs.

It is a program allowing to manage cutting processes with blades, it enables input of rectilinear as well as curvilinear shapes (steps, kitchen work-tops, rectangles, covers) using pre-defined shapes in the program or imported from DXF files.

Based on the surface available it is possible to automatically set-up the pieces positioning and the sequence of cuts, so optimizing times and reducing material waste.

The software is including functions such as anti-collision of pieces, manual and automatic pieces nesting, book matching, production and orders statistics management, rendering of pieces and holes. Parametrix can be combined with Photoslab.

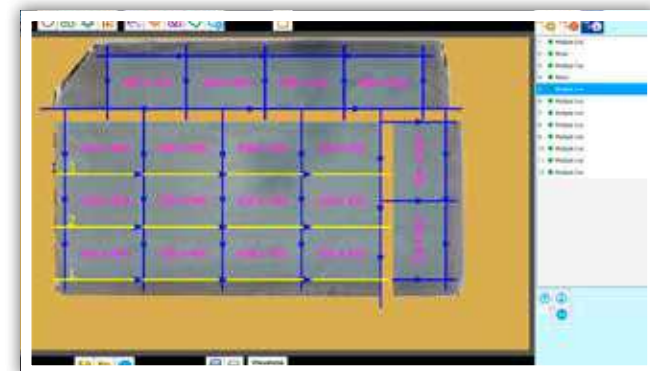

## Automatic nesting (included)

It automatically inserts the pieces in the work area optimizing the exploitation of the slab.

## Drilling and cutting with milling tool (included)

It allows to manage the use of tools and automatic change from disk to tool.

## Management and modification of cuts (included)

It allows to modify, add and remove the set cuts and to change the order of execution.

## Positioning of the pieces on the slab (included)

It helps to optimize the programming and processing phases through some functions.

## Book matching (optional)

Allows to preview a 2D rendering of the result before the processing is performed.

## DM\_TL (optional)

Program for smoothing / polishing / brushing.

## Photoslab (supplied with camera for slabs)

Through the use of a camera positioned above the machine and the acquisition software, the slab will be detected automatically. The system thus makes it possible to optimize the exploitation of the slab dimensions and to speed up the positioning of the pieces, avoiding possible defects or allowing to perform cuts following the veins of the material. The software is automatically enable with with the installation of the "Camera for slabs" accessory.

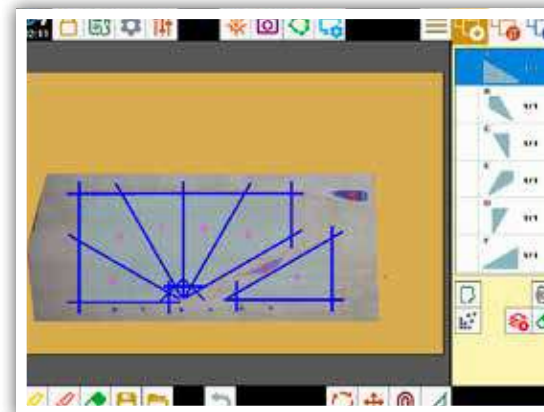

# DDX EasySTONE

OPTIONAL

DDX Easystone is powerful, simple and intuitive CAD / CAM software for machines Donatoni.

The software allows to design, import and execute 2D and 3D files in DXF, IGES, STL, PNT, STEP and RHINO formats and to define surfaces and shapes through laser scanning.

Multiple processes can be set: roughing, drilling, profiling, emptying and polishing, which can be carried out by optimizing the execution process.

After the import, the software optimizes processing paths, performs roughing / finishing taking into account the raw material resulting after processing.

With EasySTONE it is possible to display the processing 3D image with virtual milling and to modify it if required. The 3D simulation of the processing, including free displacements, is realistic as it is based on the Customer's machine model and shows the three-dimensional model of the working center, of the bench, of the motors, the tools, the sub-pieces and the pieces . Once the design phase is completed, EasySTONE generates the piece-programs and sends it directly to the Customer's working center.

Finally, it calculates times, lengths and processing costs, allowing accurate reporting of the work performed.

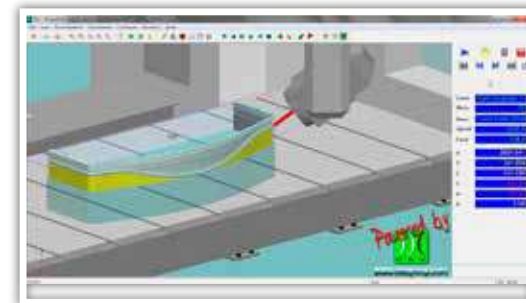

**Drawing:** the software provides drawing tools allowing to easily create 2D shapes and even complex 3D surfaces. It is also possible to import surfaces produced with other modeling software or coming from the scanning of real objects.

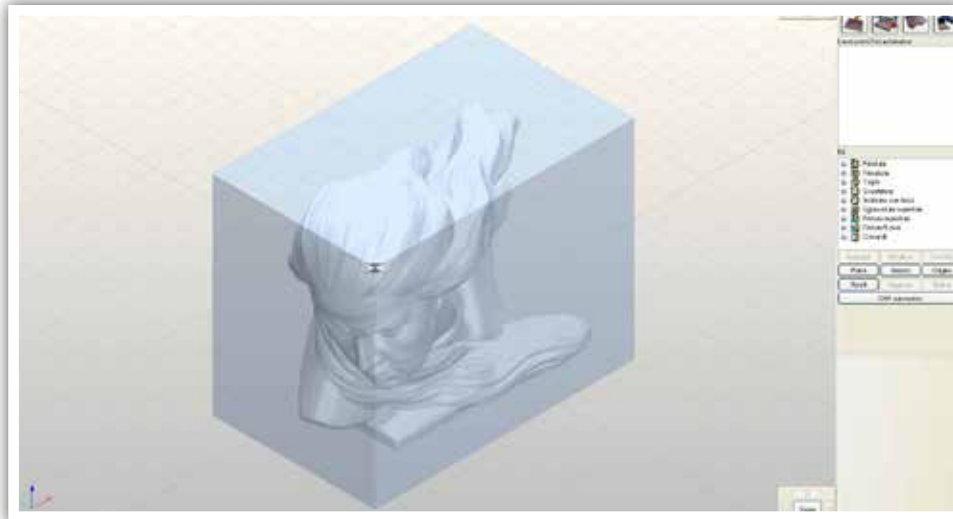

**Tool storage management:** the software manage tool magazine and creates working kits. This allows to create a database by type of processing, containing all the necessary tool parameters already set, saving time for programming.

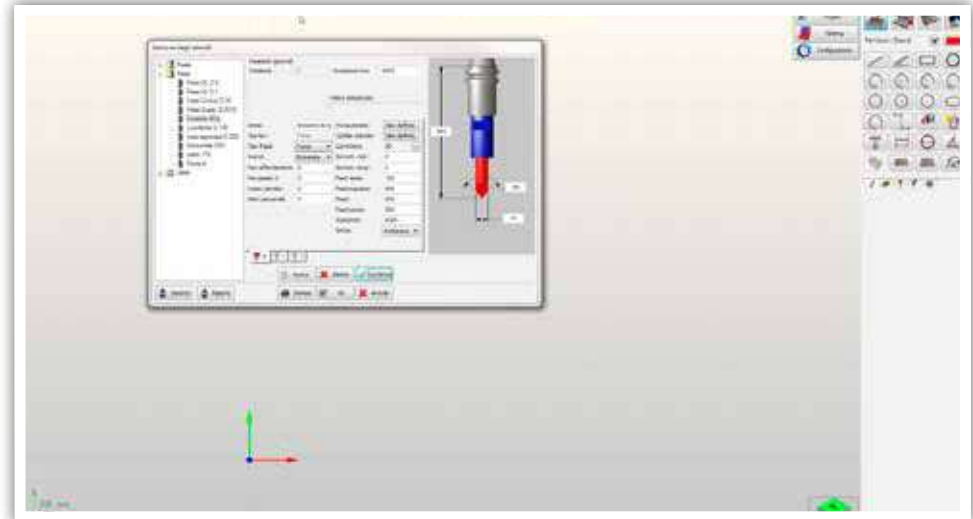

**Working management:** the project that has to be realized out often requires the use different processes (finishing, roughing ...), which have to be carried out using different tools. The application of these processes is done directly on 3D model and the operator immediately has feedback on the tool paths and uptake so allowing you to deal with the process in the most congenial way.

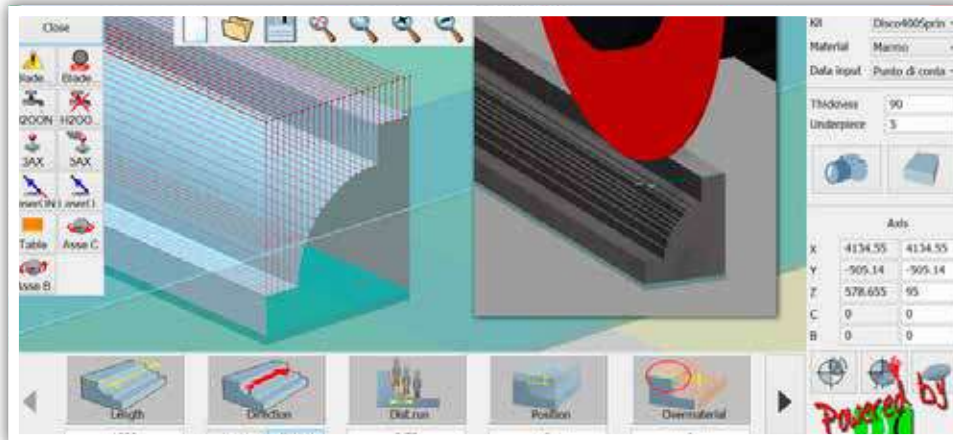

**Simulation:** the program allows to simulate the operations that will be actually performed by providing a model of the machine, tools and the material processed. In the simulator, during the movement of the tool on the material, it will be possible to display the actual material removal and to have a preview vision of the final result.

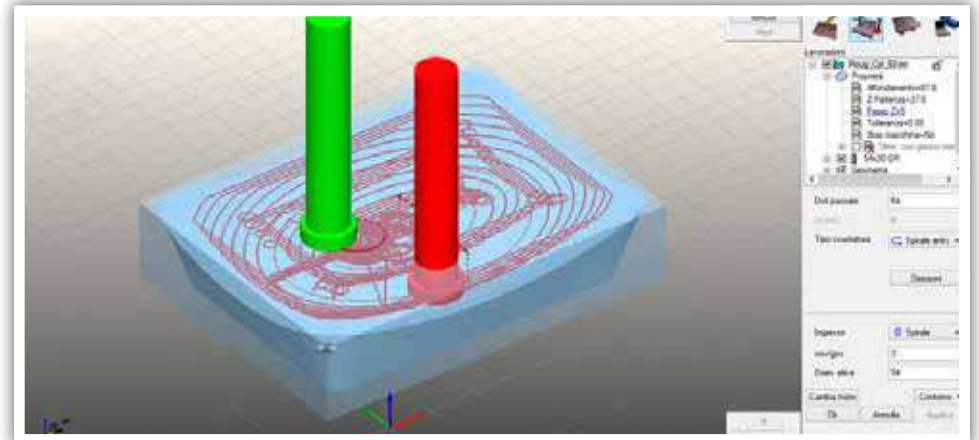

# WITH DONATONI YOU ARE NEVER ALONE

AFTERSALES  
SERVICE AND ASSISTANCE

The relationship with the customer does not end with the supply of the product but continues and is strengthened through a reciprocal collaboration which creates value for both customer and supplier.





# **DIRECT CONNECTION WITH OUR TECHNICIANS**

## **MACHINE INSTALLATION**

Our machine are installed by highly specialized technicians granting extraordinary levels of professional work. Installation includes a careful installation service, commissioning of the machine and training of operators according to the model of machine installed.

## **ON SITE ASSISTANCE**

We provide on site assistance at the clients premises if not possible to use the Tele Assistance by modem.

## **CAD-CAM TECHNICAL ADVICE**

we help our customers in creating and designing projects and objects.

The commitment to our Customers continues even after delivery of the machine, offering a service of support and aftersales service of utmost quality. For Donatoni Macchine the best service is to supply **efficient and long-lasting machines which require little maintenance and aftersales assistance.**

## **DIRECT CONNECTION - ON-LINE ASSISTANCE**

Each machine is supplied with a system that enables it to be connected by Tele-Assistance to our After-sale service (we require connection to the network via a cable). This service enables our technical staff to virtually access the customer machine and to carry out checks, updates and to provide technical assistance as if they were there at the machine location in person.

## **PARTS AND REPLACEMENTS SERVICE**

We handle requests for parts and replacements in any part of the world, in short time frames in order to minimise machine down-time.

## **EXTENSIVE SALES AND ASSISTANCE STRUCTURE**

Donatoni is present in many countries worldwide thanks to a structure of reliable and competent partners and agents, among which the Biesse group Intermac branches.

We believe that **the added value that we can offer customers is a series of services including technical advice and support and training activities** for operators regarding technical aspects or the software.

## **THEORETICAL/PRACTICAL TRAINING**

Training courses and update courses regarding new applications and software at our offices or at customer premises. Our offices are equipped to host courses for technicians and operators. The rooms are next to the machines on display in our show room and therefore this allows tests and checks to be carried out directly on the console of the machine and the level of learning can be evaluated.



# TECHNICAL DATA

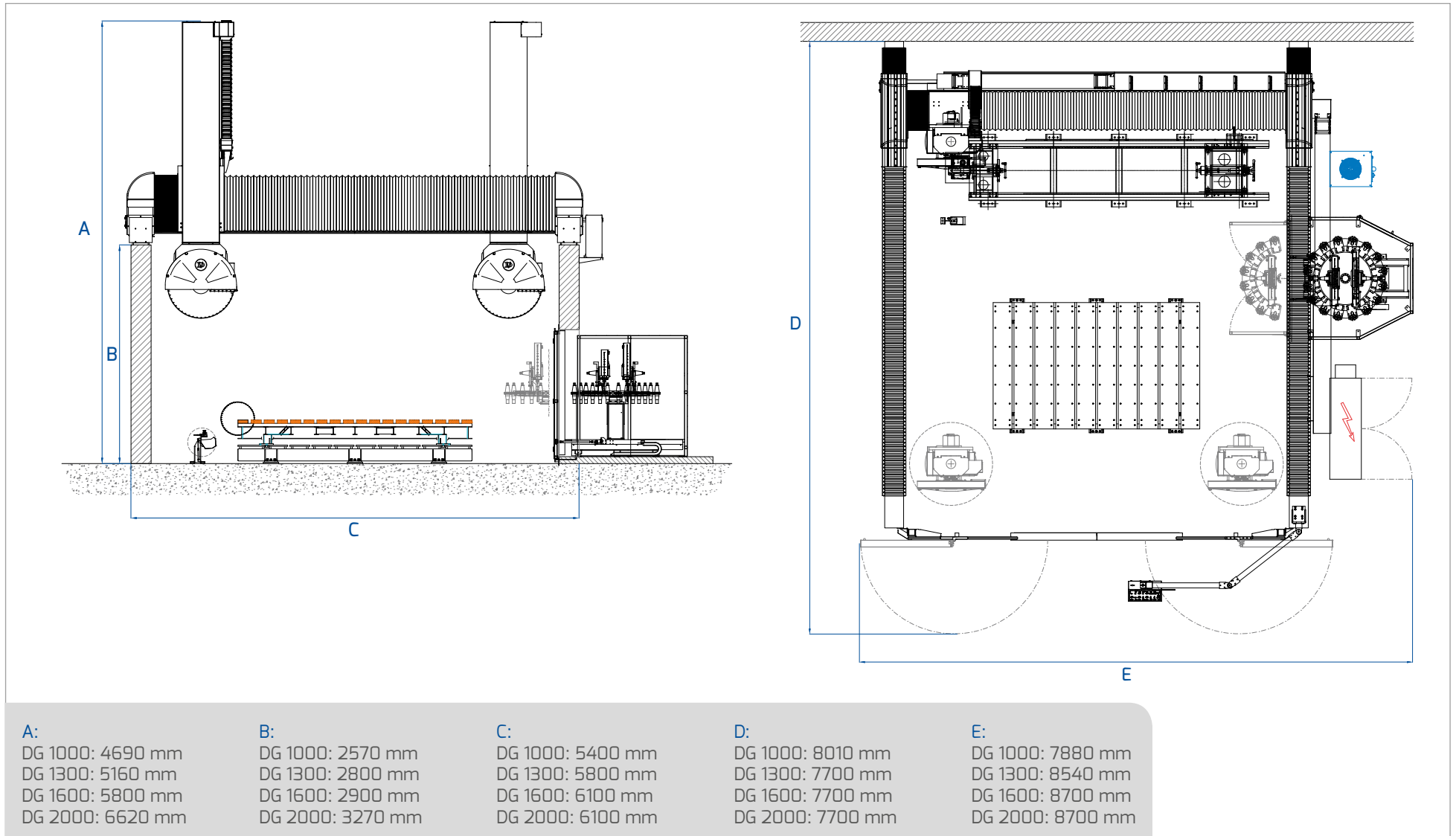

# DG 1000/1300/1600/2000

		1000	1300	1600	2000
Max number of interpolated axes	N°	5 / 6	5 / 6	5 / 6	5 / 6
Carriage stroke axis X	mm in	3800 149,6	4300 (4200 opt.) 169,2 (165,3 opt.)	4600 (4400 opt.) 181,1 (173,2 opt.)	4600 (4400 opt.) 181,1 (173,2 opt.)
Bridge stroke axis Y	mm in	3000 118,1	3000 118,1	3000 118,1	3000 118,1
Vertical stroke of the head axis Z	mm in	1000 39,3	1300 51,1	1600 62,9	2000 78,7
Disc head rotation (axis C)	degrees	-5° / +545°	-5° / +545°	-5° / +545°	-5° / +545°
Disc head tilting movement (axis A)	degrees	-20° / +200°	-20° / +200°	-20° / +200°	-20° / +200°
Working table dimensions	mm in	2000 x 3500 78,7 x 137,7	2000 x 3500 78,7 x 137,7	2000 x 3500 78,7 x 137,7	2000 x 3500 78,7 x 137,7
Minimum disc diameter	mm in	500 19,6	500 19,6	500 19,6	500 19,6
Max disc diameter	mm in	1000 (opt. 1100) 39,3 (opt. 43,3)	1000 (1200 opt.) 39,3 (47,2 opt.)	1000 (1200 opt.) 39,3 (47,2 opt.)	1000 (1200 opt.) 39,3 (47,2 opt.)
Max cutting depth	mm in	360 (opt. 410) 14,17 (opt. 16,1)	360 (460 opt.) 14,1 (18,1 opt.)	360 (460 opt.) 14,1 (18,1 opt.)	360 (460 opt.) 14,1 (18,1 opt.)
Electro-spindle motor power	kW Hp	41 / 56 54,9 / 56	41 / 56 54,9 / 56	41 / 56 54,9 / 56	41 / 56 54,9 / 56
Tools rotation with inverter	Rpm	0 - 8000	0 - 8000	0 - 8000	0 - 8000
Tool connection cone	ISO	50	50	50	50
Max speed axis X	m / min ft / min	0 - 40 0 - 131,2	0 - 40 0 - 131,2	0 - 40 0 - 131,2	0 - 40 0 - 131,2
Max speed axis Y	m / min ft / min	0 - 40 0 - 131,2	0 - 40 0 - 131,2	0 - 40 0 - 131,2	0 - 40 0 - 131,2
Max speed axis Z	m / min ft / min	0 - 13 0 - 42,6	0 - 13 0 - 42,6	0 - 15 0 - 49,2	0 - 15 0 - 49,2
Max speed of axes X Y	m / min ft / min	0 - 40 0 - 131,2	0 - 40 0 - 131,2	0 - 40 0 - 131,2	0 - 40 0 - 131,2
Water consumption	L / min gal / min	50 13,2	50 13,2	50 13,2	50 13,2
Air consumption	L / min gal / min	20 5,2	20 5,2	20 5,2	20 5,2
Standard voltage	Volt / Hz	400 / 50	400 / 50	400 / 50	400 / 50
Total weight standard machine	kg	9300	11000	11800	12000

The technical data and images in this catalog are indicative and do not constitute a constraint. The manufacturer reserves the right to make changes to the product, technical data and images without prior notice.

# GAMMA

## BRIDGE SAWS



Spin 625 cnc



Jet 625 cnc



Echo 725 cnc



Sprinter 825 cnc



Quadrix DV 1100



Quadrix XL 1600



MULTI-FUNCTIONAL CUTTING CENTRE



Quadrix DG  
1000/1300/1600/2000

ROBOT



Cyberstone CR01

POLISHING AND CALIBRATION SYSTEMS



Zenit

UNIVERSAL CUTTING CENTRE



Kronos 600 / 800

CUTTING LINES



SX3/SX-5

SLAB LOADING / UNLOADING



Geko Loader



# ALL IN ONE



THREE EXCELLENCES,  
ONE PARTNER.



Three leaders in the stone machining sector, combine skill, technology and a widespread distribution network to support customers in the creation of the intelligent factory, elevating the service provided in order to ensure 360° customer care.



[INTERMAC.COM](http://INTERMAC.COM)  
[DONATONIMACCHINE.EU](http://DONATONIMACCHINE.EU)  
[MONTRESOR.NET](http://MONTRESOR.NET)





### **Donatoni Macchine Srl**

Via Napoleone 14, 37015 Domegliara - Sant'Ambrogio di Valpolicella / Italy

Tel. +39 045 6862548

Fax +39 045 688 43 47

info@donatonimacchine.eu

www.donatonimacchine.eu

**Donatoni Macchine**, founded by Vittorio Donatoni in 1959 in Domegliara, one of the main marble and granite processing districts, is recognised, thanks to their years of experience gained in the natural stone industry during this time, as one of the world leaders in manufacturing **cutting-edge machines of very high quality for working stone.**

**Constant research, technological innovation and customer service** are key concepts for the company and in order to pursue them the company employs highly qualified technical and commercial personnel, in order to guarantee the end customer a **product that reflects their expectations in terms of quality and performance.**